

Instructor Directions: Print one Lucy per student. Color, cut, and tape to a straw, craft stick or paper bag.
Use Lucy during lessons as a “math helper” puppet.

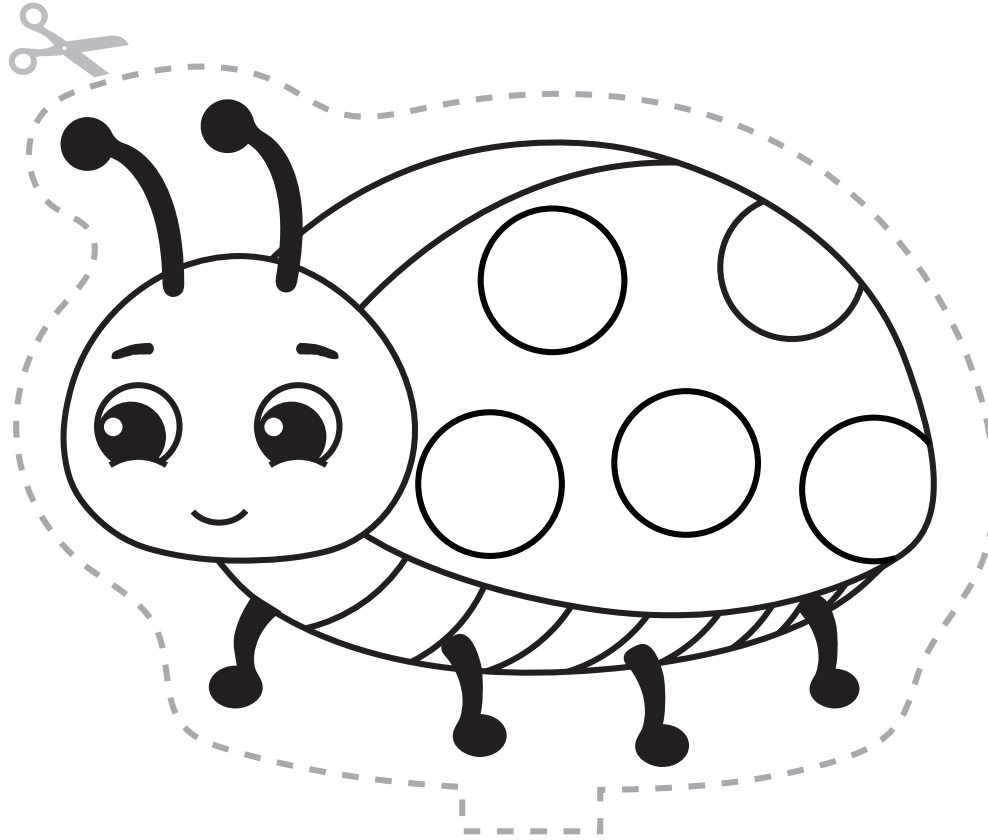

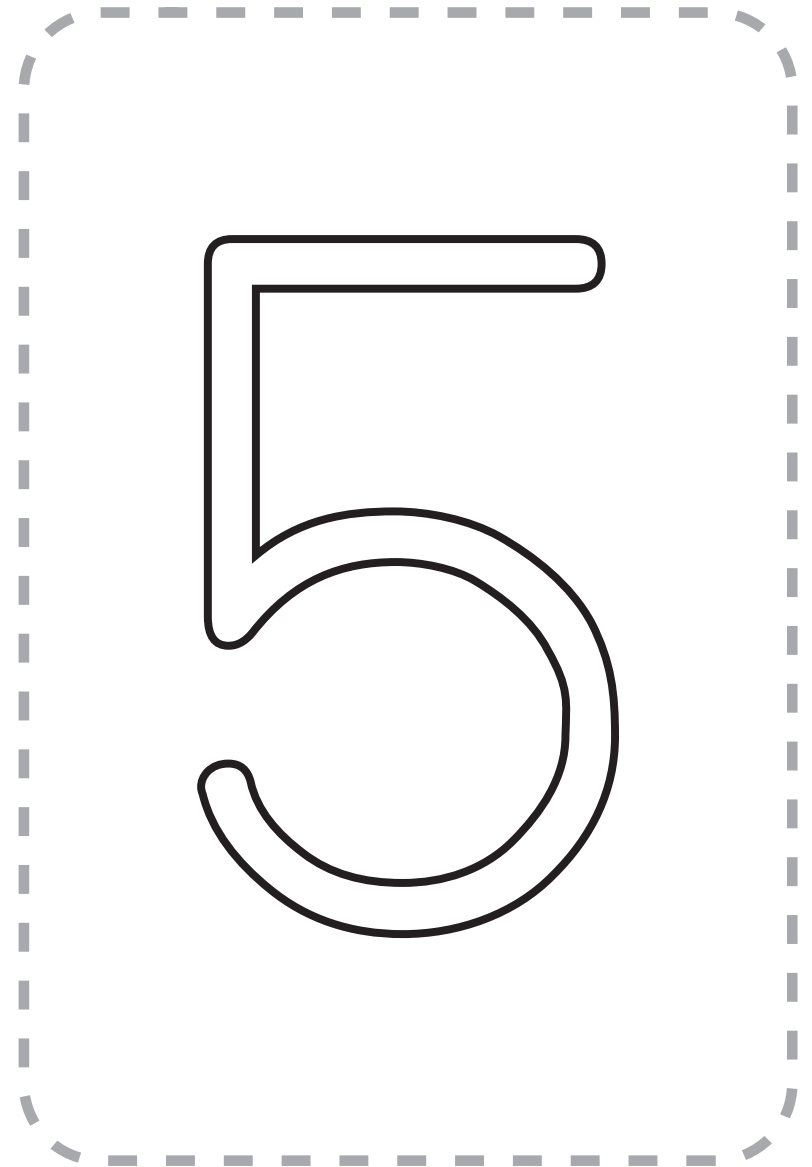
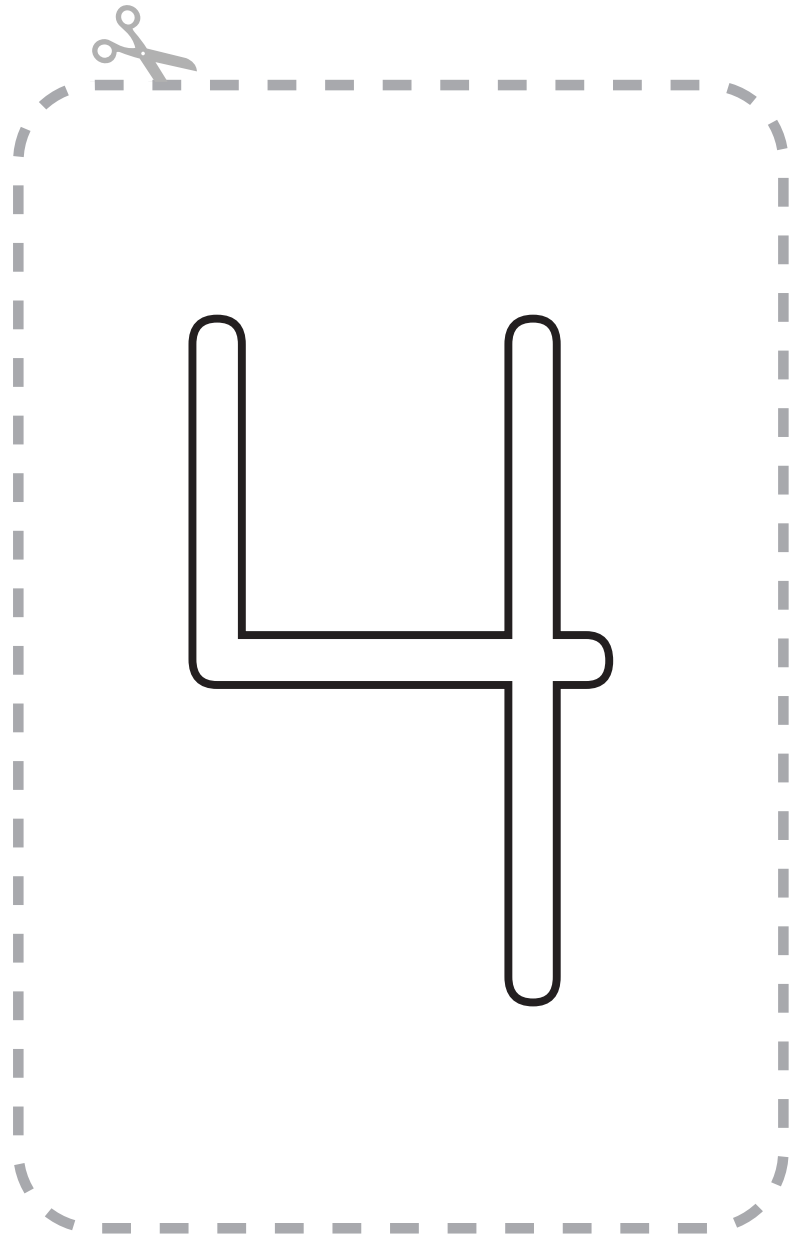

Count and Compare

Have your student count each group aloud and write the matching number.
Use this as a conversation tool for comparing quantities.

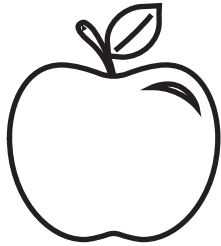

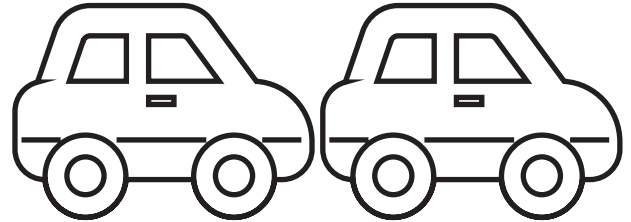

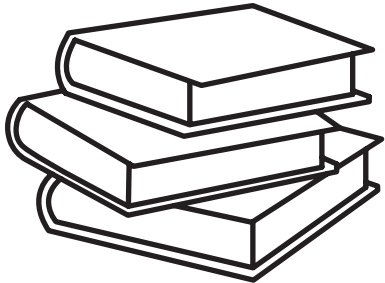

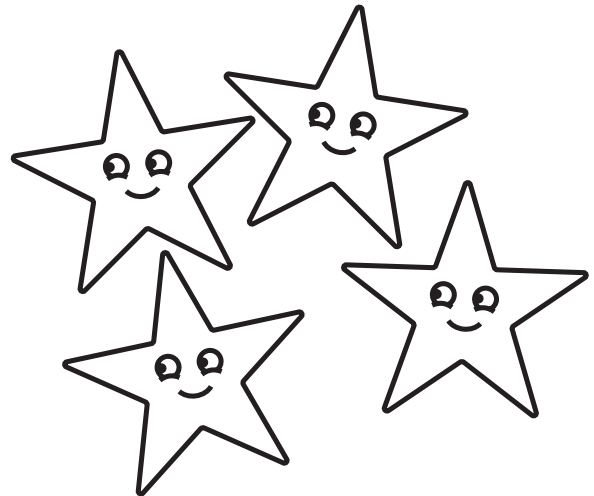

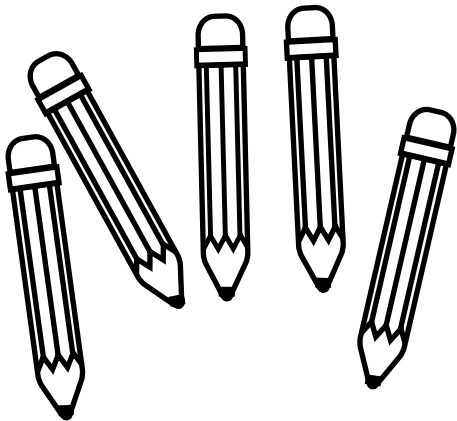

Tracing Numbers

Use your finger to trace the numbers and follow the arrows. Then use a crayon or marker to trace these by yourself! Say the number as you trace it.

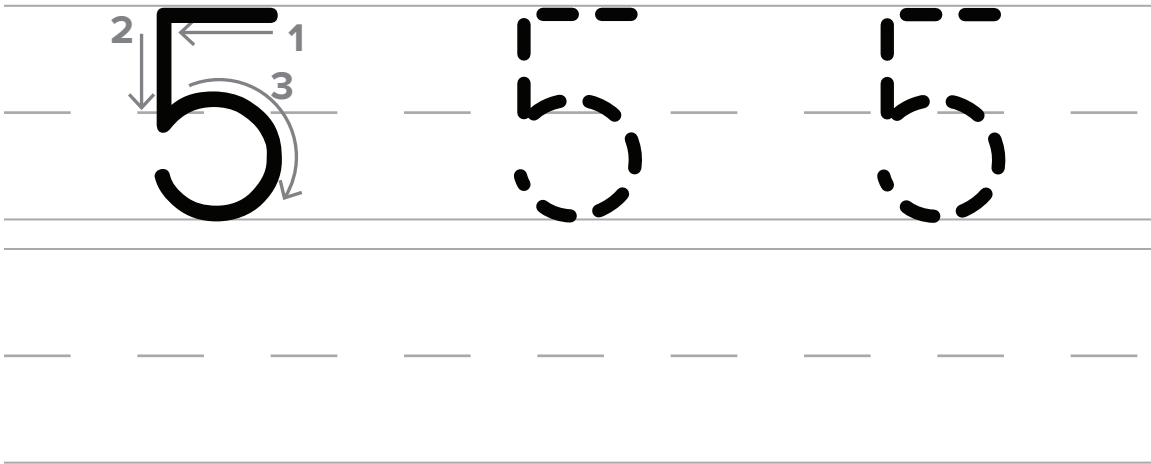
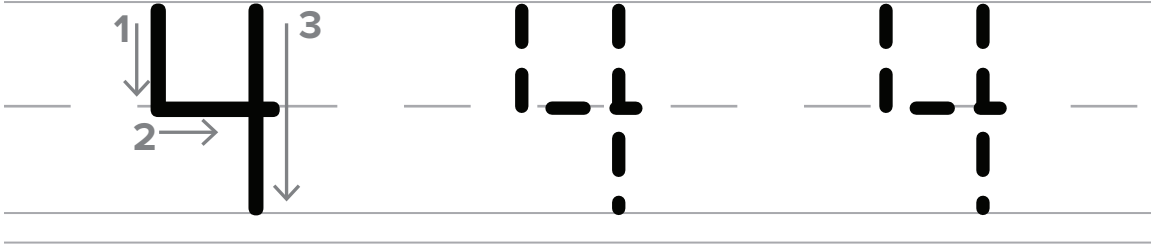
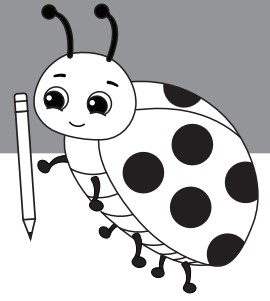

Find, build, and glue the right number of items onto each float. Then trace the float's number.

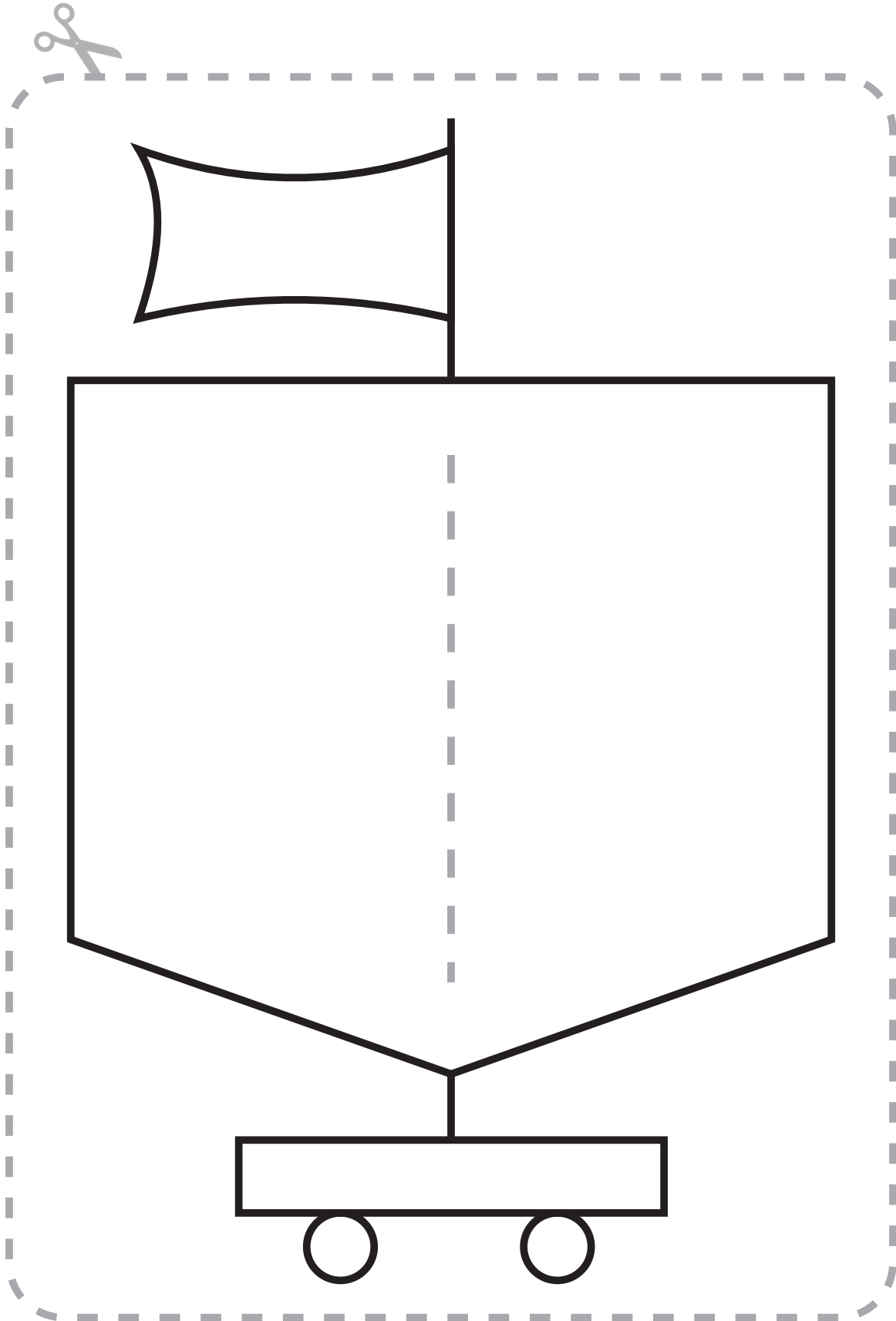

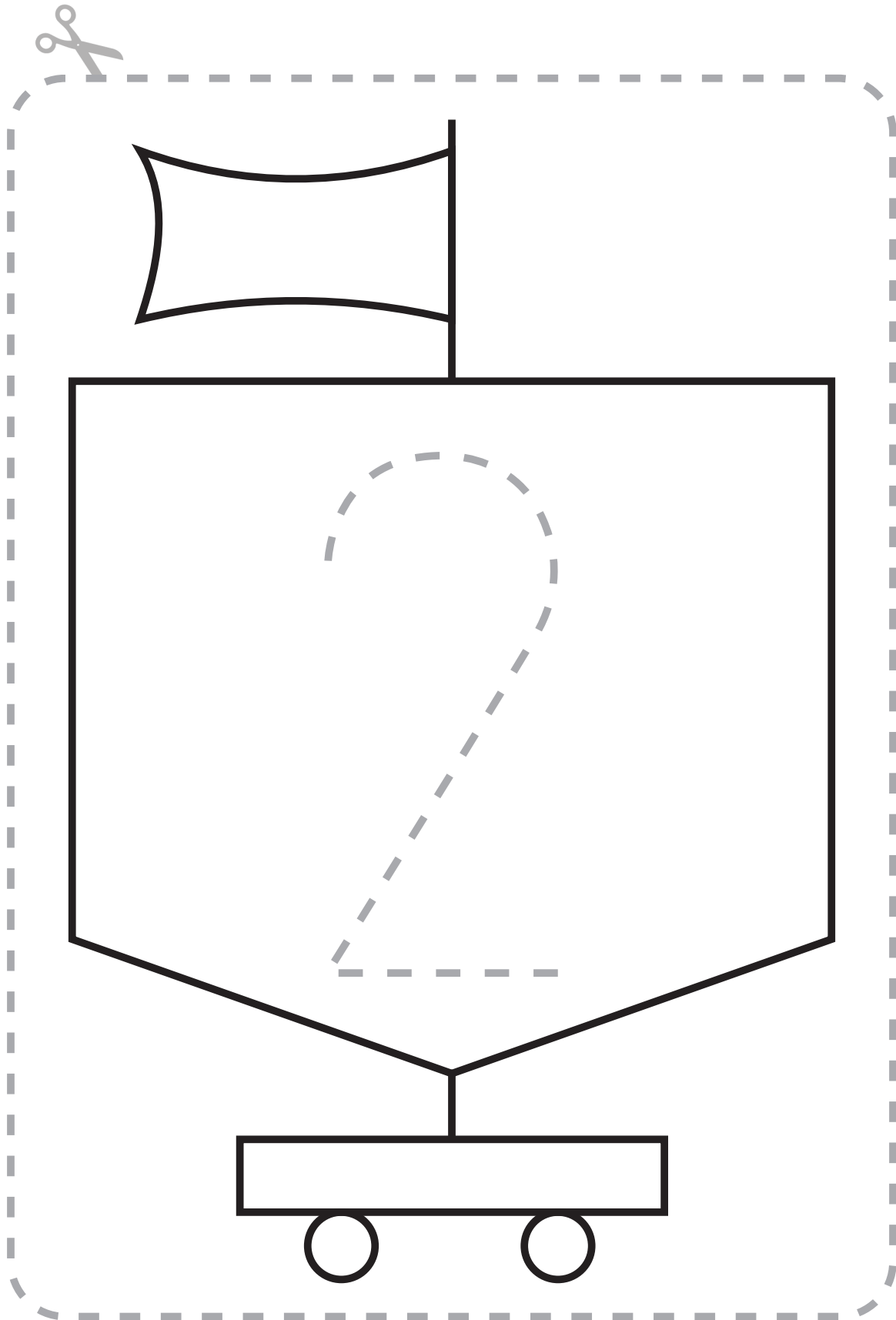

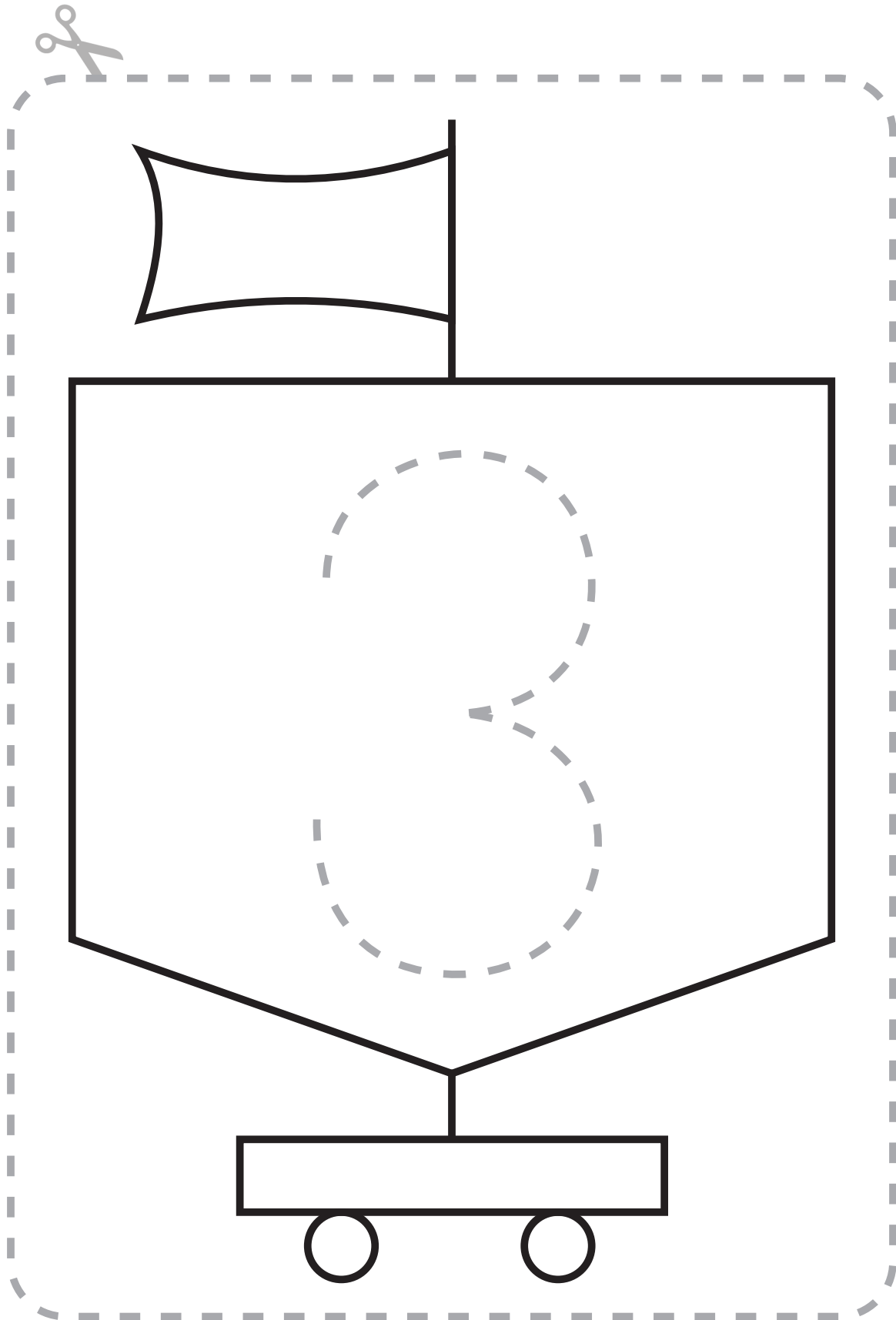

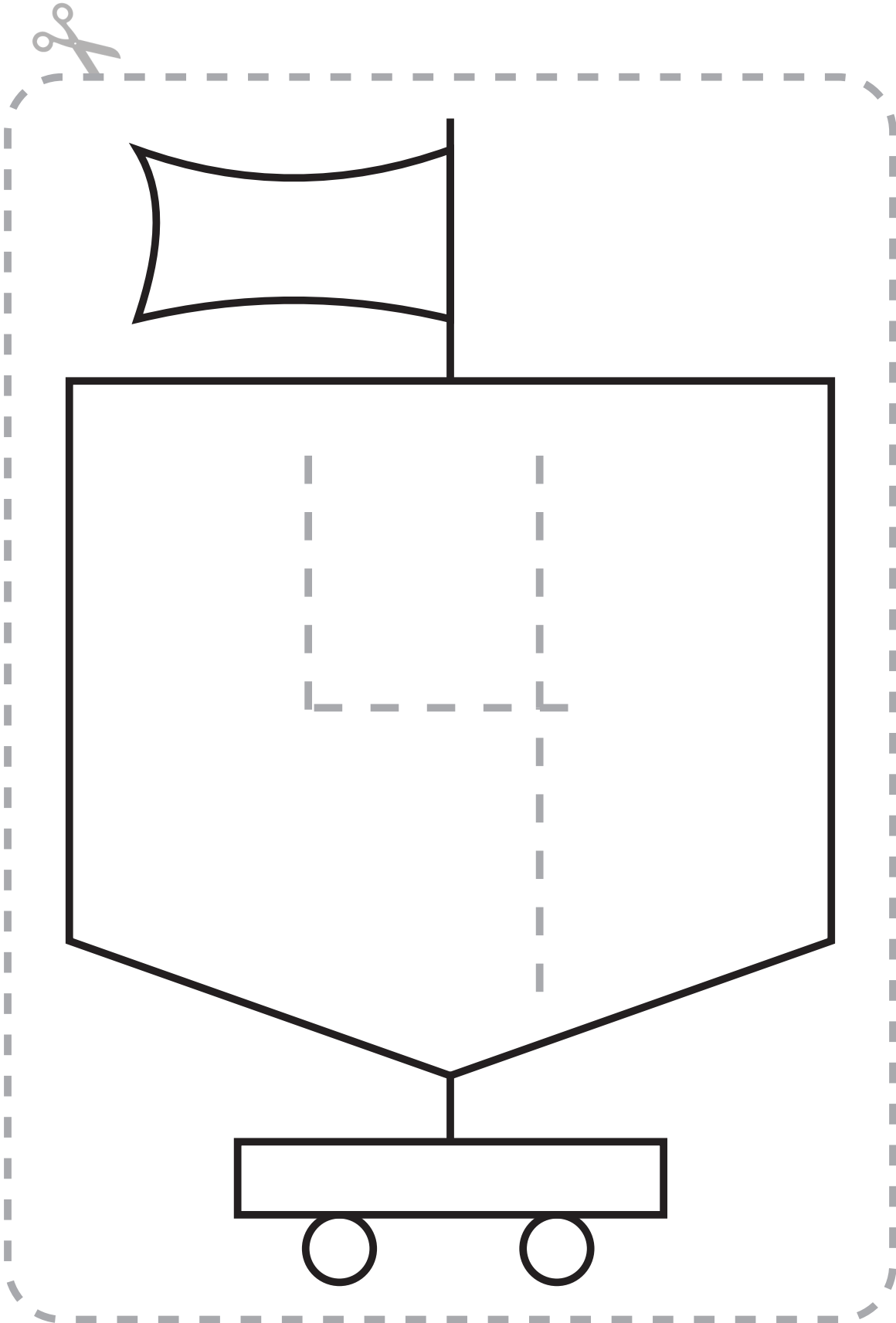

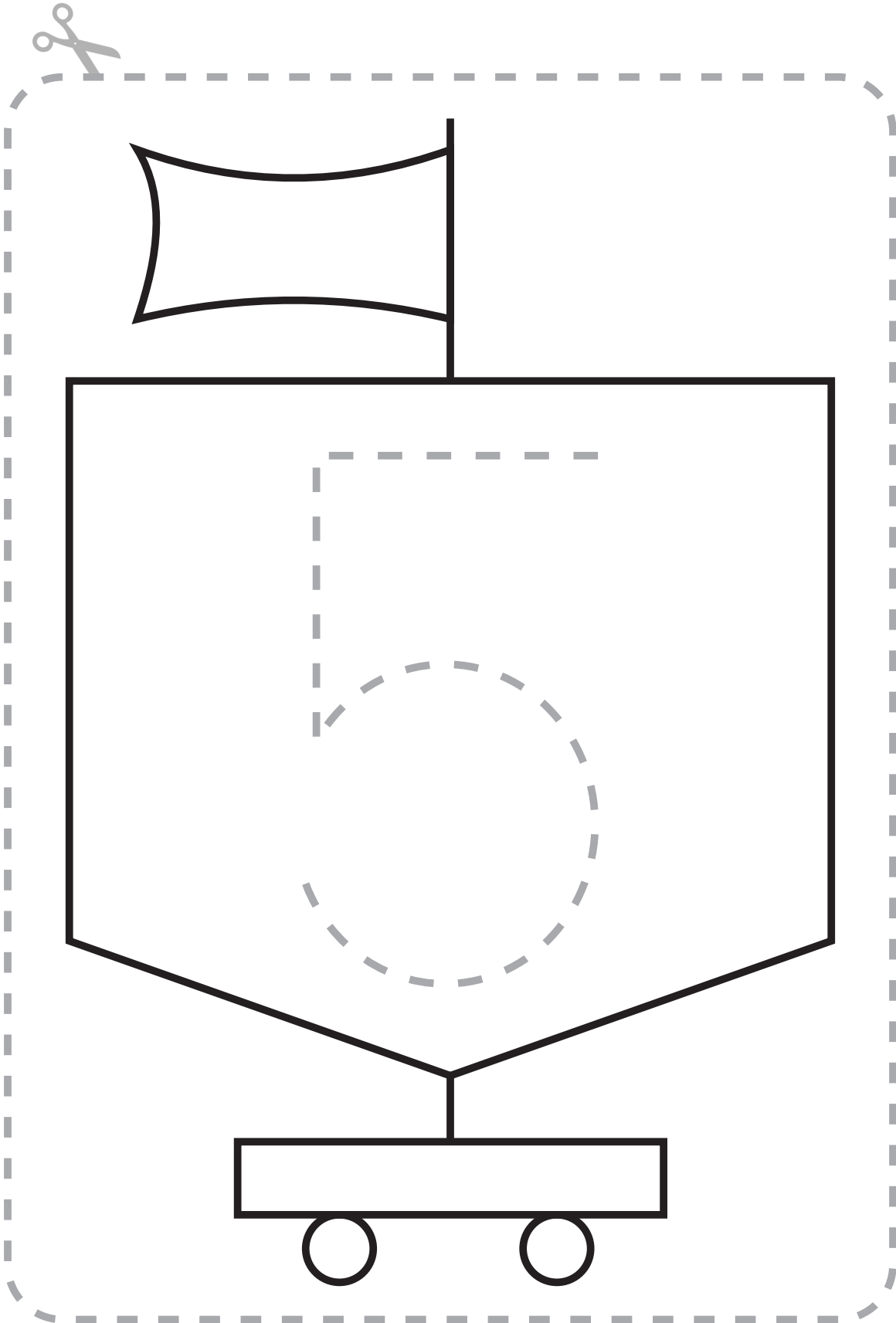

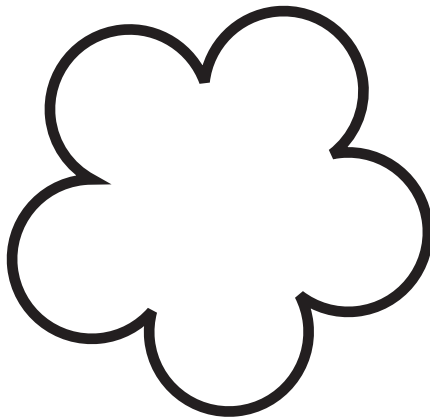
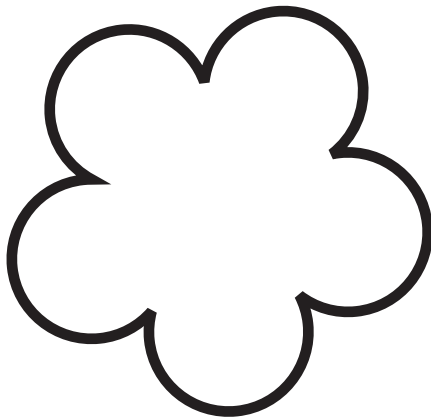
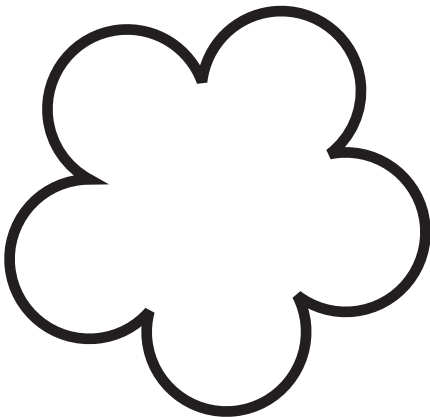
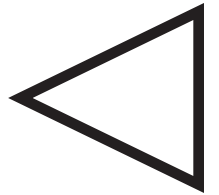
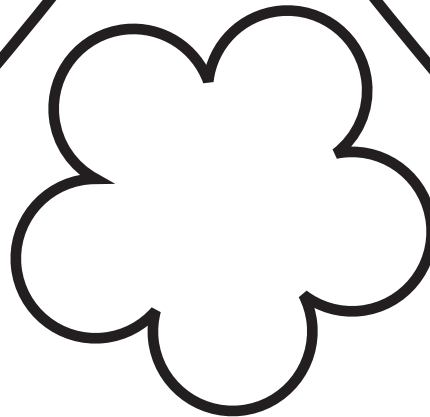
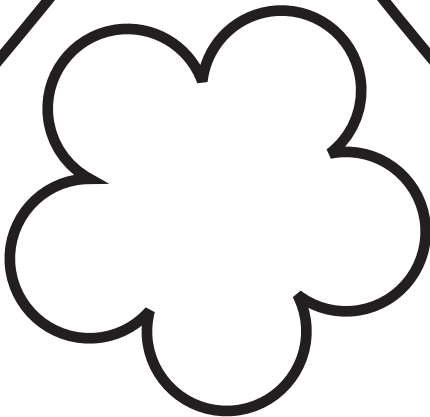
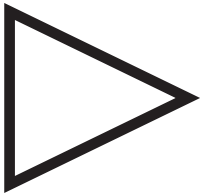
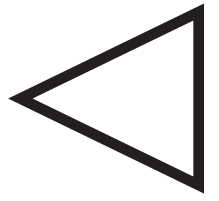
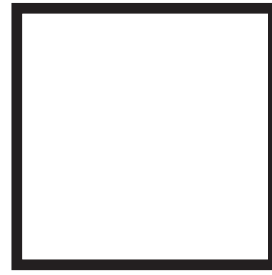
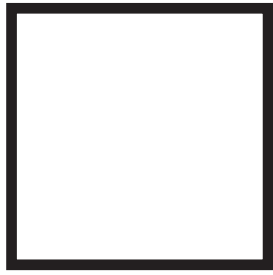
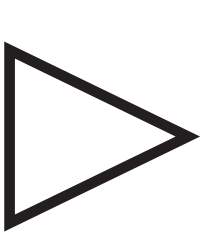
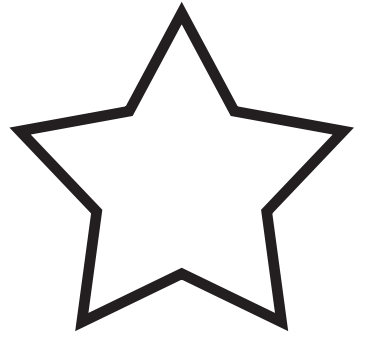
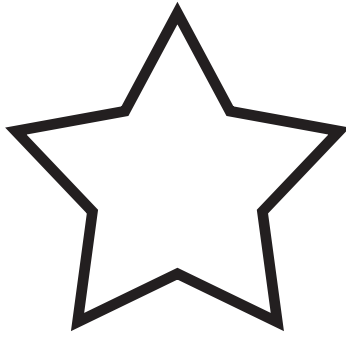

3

I can count to 5!

NAME

DATE

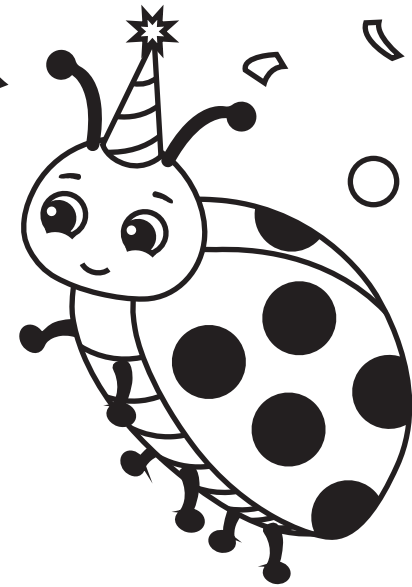

4

5

